

FEATURES

- The diaphragm pulse valves are especially designed for dust collector service applications, combining high flow, long life and extremely fast opening and closing to produce reliable and economical operation
- The high flow, angle type bodies, springless construction, in combination with the special diaphragm assemblies give the unique operating features required for dust collector service applications
- Integral compression fittings for fast, easy, secure installation
- Built-in silencers guarantee noise free operation and avoid foreign particles entering the valve
- The integral operators are provided with epoxy moulded F-class coils. Various optional waterproof and explosionproof solenoids for use in potentially explosive atmospheres (gas & dust) according to Directive ATEX 2014/34/EU can be mounted on the same basic valve
- The components satisfy all relevant EC directives



GENERAL

Differential pressure (PS) 0,35 - 8,5 bar [1 bar = 100kPa]
Ambient temperature range -20 to +85°C

fluid (*)	temperature range (TS)	piston/diaphragm
air	-20 to +85 °C	TPE (thermoplastic polyester elastomer)
	-20 to +120 °C	FPM (fluoroelastomer)

CONSTRUCTION

(*) Ensure that the compatibility of the fluids in contact with the materials is verified

Body	Aluminium / Stainless steel 316L
Core tube	Stainless steel
Core and plugnut	Stainless steel
Core spring	Stainless steel
Sealings & disc	NBR (nitrile)
Diaphragm	TPE or FPM
Shading coil	Copper
Coil insulation class	F
Connector	Spade plug (cable Ø 6 - 10 mm), ISO 4400
Electrical safety	IEC 335

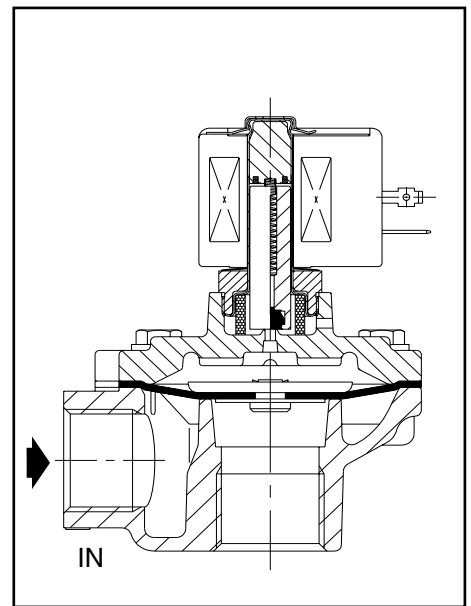

ELECTRICAL CHARACTERISTICS

Standard voltages DC (=) : 24V
 (Other voltages and 60 Hz on request) AC (~) : 24V - 115V - 230V / 50 Hz

coil type	Leistung				ambient temperature range (°C)	protection	replacement coil	
	inrush ~ (VA)	holding ~ (VA) (W)		hot/cold = (W)			~ 230 V/50 Hz	= 24 V DC
		(VA)	(W)					
CM6-FT	34	15,6	6	-	-20 to +85	IP65/IP67	400325-117	-
CM6-FT (1)	-	-	-	14 / 20,8			IP65/IP67	-

(1) Intermittent duty, Relative Duty Time is 10%. Max. on time is 1 min.

SPECIFICATIONS

pipe size	orifice size	flow coefficient Kv		operating pressure differential (bar)		prefix optional solenoids					catalogue number		FPM	
				min.	max. (PS)	ATEX					Aluminium	stainless steel AISI 316L		
G	(mm)	(m³/h)	(l/min)		air (*)	SC	WP	SG	EM (T)	NF				
(G) - Threaded pipe connection														
3/4	25	14	233	0,35	8,5	●	●	●	●	●		G353A043	G353D132	V
1	25	17	283			●	●	●	●	●			G353A044	G353D133
Ø - Compression fitting pipe connection														
3/4	25	14	233	0,35	8,5	●	●	●	●	●		G353-052	-	V
1	25	17	283			●	●	●	●	●			G353-053	-

● : available feature

OPTIONS

- Waterproof enclosure with embedded screw terminal coil according to protection class IP67, CEE 10
- Explosionproof solenoids for hazardous locations according to "ATEX" and national standards
- IECEX certification
- Plug with visual indication and/or peak voltage suppression
- Electronic timer
- Valves can also be supplied with FPM (fluorelastomer) diaphragm and seal materials. Use the appropriate optional suffix letter for identification

INSTALLATION

- The valves can be mounted in any position without affecting operation
- Pipe connection identifier is: G = G (ISO 228/1) or compression fitting
- For compression fitting types tightness is achieved by the compressed gasket on the blow tube
- The use of the rubber gaskets as sealing members will allow a slight misalignment in piping when using compression fittings
- Other pipe threads are available on request
- Installation/maintenance instructions are included with each valve
- Spare parts kit and replacement coils on request

DIMENSIONS (mm), WEIGHT (kg)

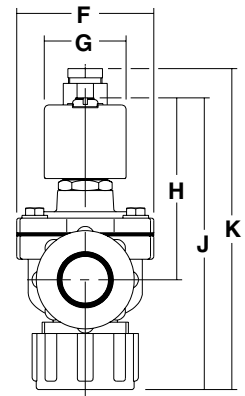
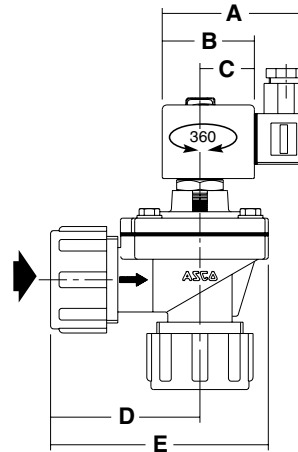
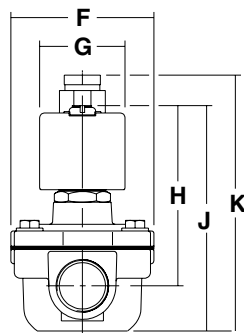
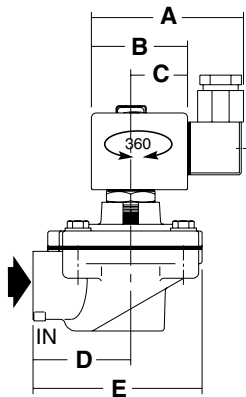

Fig. 1 threaded type

Fig. 2 compression fitting type

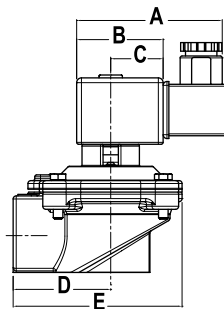
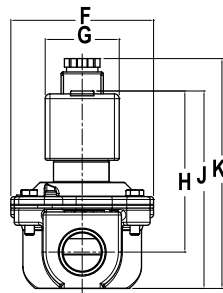

Fig. 3: threaded type - Stainless steel

catalogue number	A	B	C	D	E	F	G	H	J	K	weight (1)	(C)
SC G353A043	75	45	27	51	89	75	39	92	113	130	0,70	Abb. 1
SC G353A044	75	45	27	51	89	75	39	92	113	130	0,65	Abb.1
SC G353-052	75	45	27	81	125	75	39	92	175	195	0,85	Abb. 2
SC G353-053	75	45	27	81	125	75	39	92	175	195	0,90	Abb. 2
SC G353D132	89	57	31	51	89	75	50	93	117	130	1,30	Abb. 3
SC G353D133	89	57	31	51	89	75	50	96	117	130	1,20	Abb. 3
Atex II3D												
SG G353A043	89	57	31	51	89	75	50	92	113	130	0,70	Abb. 3
SG G353A044	89	57	31	51	89	75	50	92	113	130	0,65	Abb.3
SG G353-052	89	57	31	81	125	75	50	92	175	195	0,85	Abb. 2
SG G353-053	89	57	31	81	125	75	50	92	175	195	0,90	Abb. 2

(1) including coil and connector (prefix SC or SG)

(C) construction type

SPARE PARTS KITS

catalogue number	spare parts kit no. ~/=
SC G353A043	C113444
SC G353A044	
SC G353-052	
SC G353-053	
SG G353A043	
SG G353A044	
SG G353-052	
SG G353-053	